



# **PRACTICAL EQUIPMENT INSPECTION BASIC REFERENCE MANUAL**

**Introducing an IFAA standard procedure  
for the inspection of archery equipment**



## CONTENTS

INTRODUCTION .....	3
THE LAY-OUT OF THE EQUIPMENT INSPECTION AREA .....	4
BASIC FLOW CHART OF THE INSPECTION PROCEDURE .....	6
DOING THE EQUIPMENT INSPECTION.....	12
THE COMPOUND BOWS .....	12
THE NEXT STEP.....	14
INSPECTING THE BOW .....	15
i.    THE COMPOUND BOW.....	15
ii.   THE RECURVE BOW.....	15
iii.  THE TRADITIONAL BOW .....	16
WHAT TO LOOK FOR WHEN INSPECTING THE BOW .....	17
THE FREESTYLE UNLIMITED BOW .....	19
THE FREESTYLE LIMITED COMPOUND BOW .....	20
THE BAREBOW COMPOUND BOW.....	21
THE BOWHUNTER UNLIMITED BOW.....	23
THE BOWHUNTER LIMITED BOW.....	25
THE BOWHUNTER COMPOUND BOW.....	26
THE FREESTYLE LIMITED RECURVE BOW .....	29
THE BAREBOW RECURVE BOW.....	30
THE BOWHUNTER RECURVE BOW .....	32
THE TRADITIONAL RECURVE BOW.....	35
THE LONG BOW .....	37
THE HISTORICAL BOW.....	40



## INTRODUCTION

**Why do we do an equipment inspection before each tournament?**

**Equipment inspection is a service to archers to assure fair competition during a tournament.**

This reference manual is a basic explanation of the practical function of the Equipment Inspectors without going into technical detail of “how and why”.

It tries to explain procedures of registration and of equipment inspection at various stages; how to behave during the inspection and what you are supposed to do and what not to do.

It explains what to look for to differentiate between similar shooting styles and what to do if a bow or bow equipment does not comply with the IFAA rules for that style.

You as an Equipment Inspector form part of the Tournament Technical Control (TTC), which is under the control of the Technical Control Officer (TCO), a senior ranking official at the tournament who is appointed by the Tournament Director and is officially approved by the IFAA.

The TCO deals with disputes and his decision is final.

As an Equipment Inspector you are not expected to argue with an archer. If an archer disagrees than you call the TCO, or one of his assistants (ATCO).

Always keep in mind that you as an Equipment Inspector may also make a mistake.

If in any doubt you should ask for a second opinion or call the TCO or one of his assistants.

If still in doubt you always call the IFAA Vice-President or one of the IFAA Officials.

Although the manual only refers to the male gender (he), both gender (male and female) are intended.



## THE LAY-OUT OF THE EQUIPMENT INSPECTION AREA.

When the inspection area is opened to the archers, the TCO, the ATCOs and you as Equipment Inspectors will face a “surge” of archers, all wanting to get their equipment inspected and approved as quickly as possible.

This surge places the inspectors under a high pressure and to relieve this pressure very often equipment is rushed through the inspection, sometimes resulting in oversights by the inspectors.

Some shooting styles are very similar and care needs to be taken in the assessment of this equipment.

To relieve the inspectors from this pressure it is important that the inspection area is set out in a manner that prevents archers to “dam up” at the inspection table (desk), but rather be some distance away.

You may need an official to “hold back” the archers so that not more than one archer is at the table for each style.

It is also important that archers stand in the correct inspection line and do not end up at a table where different styles are inspected. They must check their equipment against the shooting styles on the IFAA information board and you may need an official at the “entrance” to assure that archers move to the correct queue area for each style.

Archers need to know beforehand what to do and where to go to, so some official should be used at the start of the waiting lines to assure that archers go to the correct waiting line.

It is also advised that archers with compound bows first submit their equipment for a speed test before they go to the inspection tables.

It is also advisable that archers, after completing the equipment inspection form, first go to a table where the correctness of the form is checked before the archer is forwarded to the correct queue line. You then know that the sheet is filled in correctly , which reduces time of equipment inspection.

On the next page is a typical lay-out of crowd control in an inspection area. It is not compulsory however and must be seen as an example only.

Some tournament organisers however may prefer a different layout.



**TYPICAL OUTLAY FOR "CROWD CONTROL" AT EQUIPMENT INSPECTION FOR BOWHUNTER EVENTS**

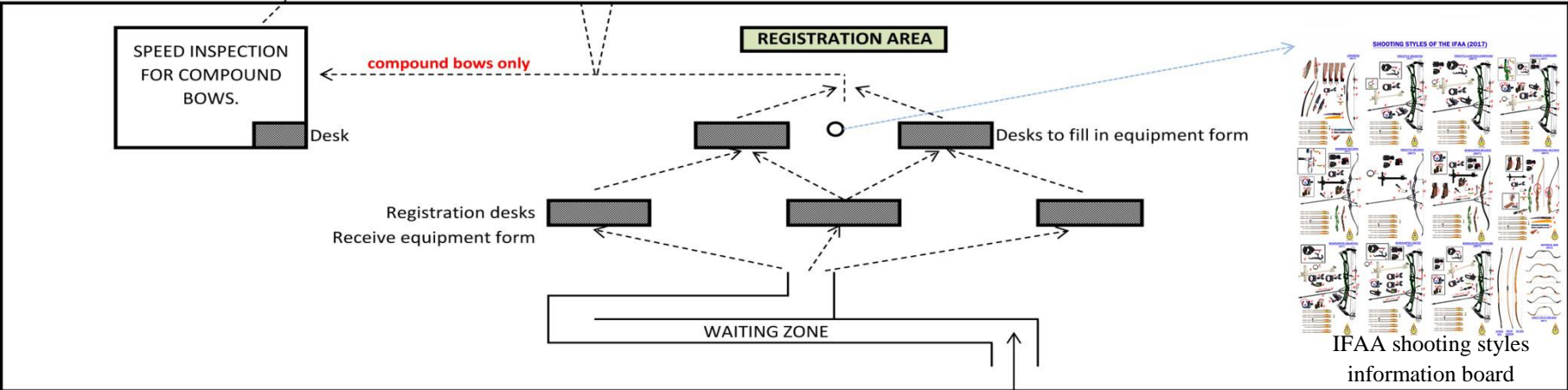
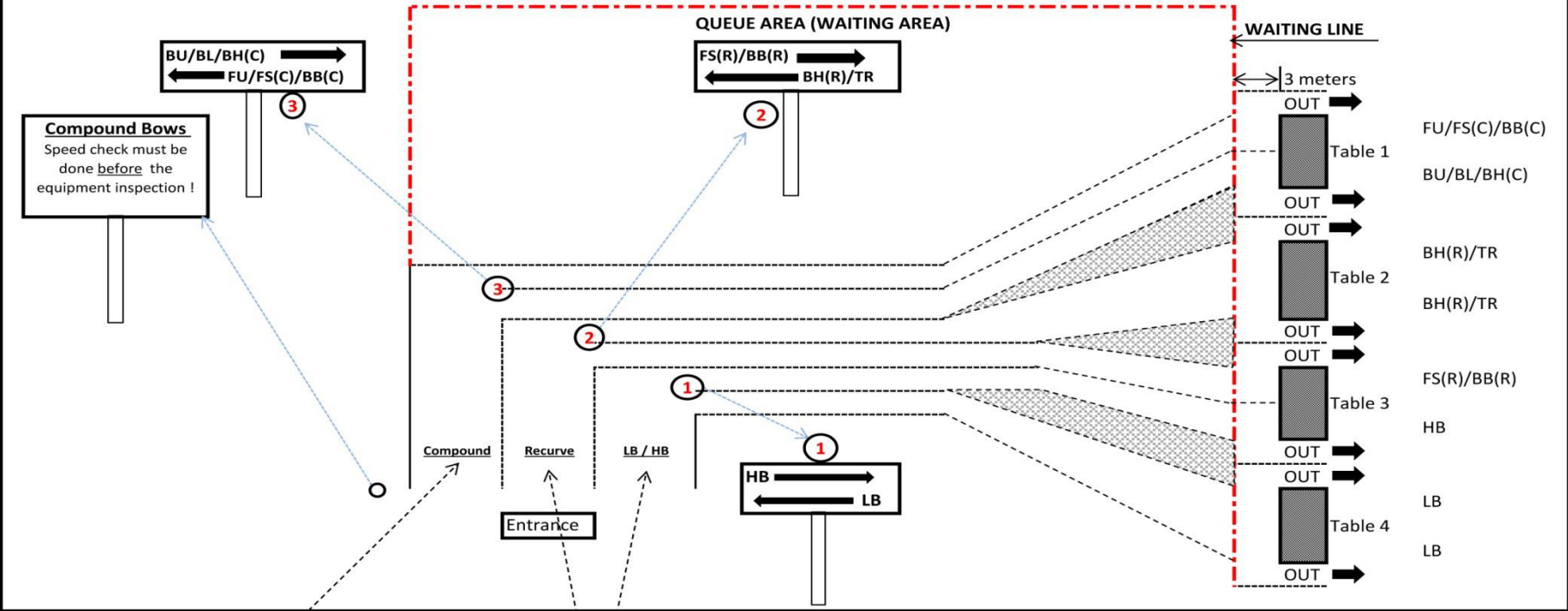

# BASIC FLOW CHART OF THE INSPECTION PROCEDURE.

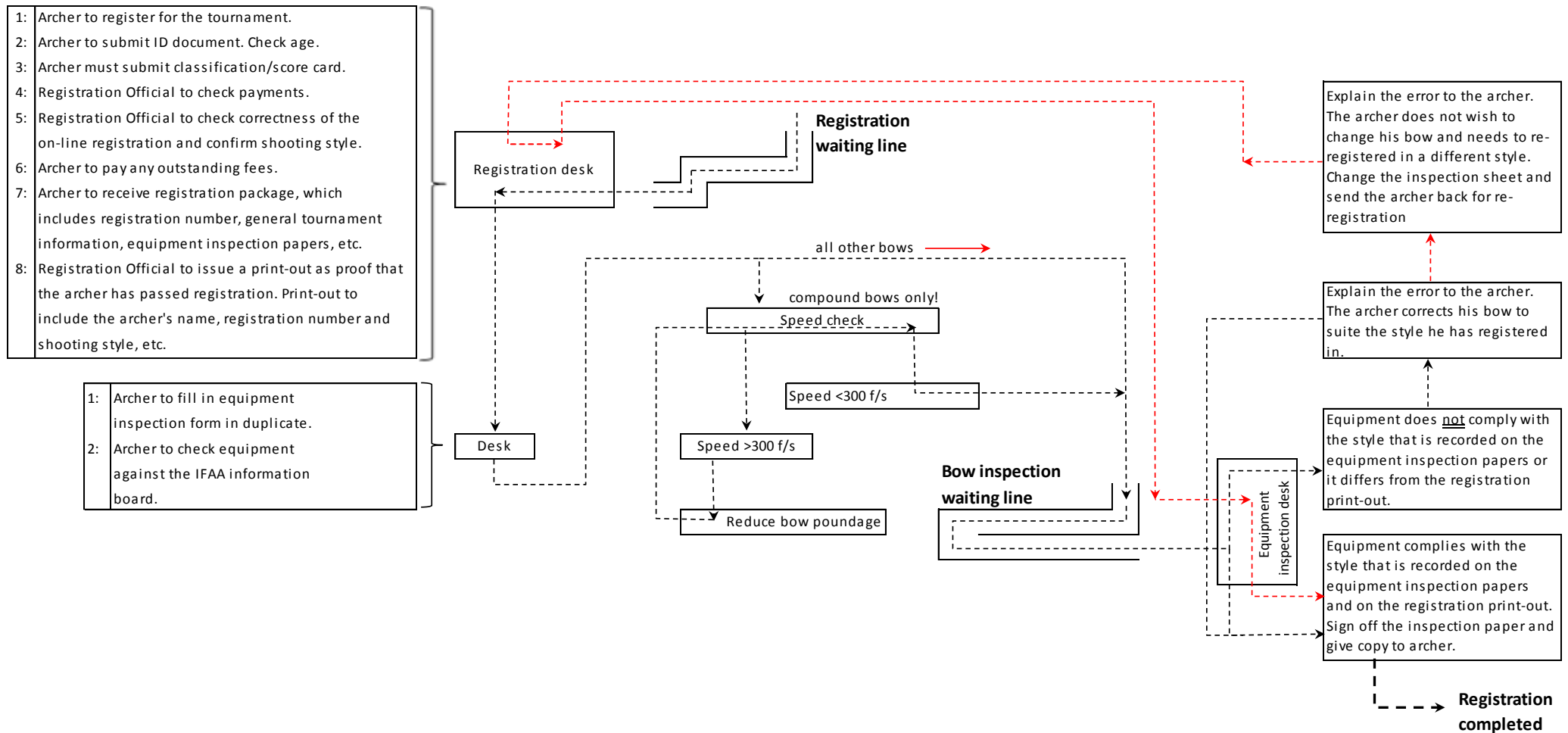

**It is very important that the correct registration procedure is followed.**

Such procedure may prevent various problems when the archers are allocated to the various ranges.

It should be understood that all archers in the same shooting style shoot on the same range on the same day.

An incorrect registration will result that an archer may shoot on the incorrect range and his score will not count. In 3D events he may not shoot the same range again at any of the following tournament days after the style is corrected. So he will lose the score of two days and will not be very happy.

So we must make double sure and thus use a double check system.

**1. At the registration desk:**

- a. When an archer arrives at the registration office, that archer must first register to attend the tournament.

He goes to the registration desk where his identity is checked as well as his age to make sure he is registered in the correct age group. Remember that the age group is determined on the first day of the tournament: e.g. if an archer turns 13 years old on the day before the tournament, that archer will shoot in the Junior division; if that archer turns 13 years old on the 1<sup>st</sup> shooting day of the tournament, he shoots in the Cub division!

Remember also that Veteran archers (55+ years) may decide if they shoot in the Adult division or in the Veteran division. It is their choice.

- b. Keep in mind that an archer may NOT change in style unless that archer receives permission from the Tournament Director! There may not be space for him on the range (the range is fully booked).

So, for instance: an archer who registers over the internet in the Barebow Recurve style cannot change to Bowhunter Recurve style at the registration desk without approval from the Tournament Director!

- c. The archer must also show proof that he is a member of a member association of the IFAA. This can be a membership card, a letter from the association or any other legal means.

Guest archers are permitted with the approval of the Tournament Director. They however do not compete for a medal!



- d. An archer must also hand over his IFAA type score record/classification card as proof that he has shot at least two similar tournaments. Do not argue with an archer who does not have a card. Call the TCO or the Tournament Director.
- e. After registration you hand the archer two equipment inspection forms, as well as any other information and any gifts by the organisers of the tournament.
- f. Print out proof of registration that includes the archer's name and the archer's shooting style in which he is registered at your desk as well as any other relevant information.

The archer is now ready to proceed with equipment inspection and must proceed to a free desk to fill in the equipment registration forms.

Keep in mind that these forms are available on the IFAA web site and some archers use that facility to fill in these equipment inspection sheets before arriving at the tournament.

This form is filled in in duplicate: one copy for the inspector and one copy for the archer.

The standard equipment inspection form is written in the English language, but it will be advantageous if such form is available in various languages, such as German, Italian, French and others.

Please display the formal pictures of the IFAA shooting styles on a large board to assist and assure the archer.

After completion of the forms the archer moves to the equipment inspection desks. Have someone available to guide the archers to the correct waiting line and avoid confusion.

## **2. At the equipment inspection desk:**

- a. When you are doing the equipment inspection keep in mind that you are providing a service! You assist the archer to make sure that his equipment complies with the rules of the style he is registered in, so that he will not be protested by other archers during the tournament or gets grouped in the wrong style.

Of course some archers do make changes to the equipment after the equipment inspection. You cannot prevent that.





The IFAA rule therefore states that the equipment inspector's decision is not final! The correctness of the archery equipment is always the responsibility of the archer and the archer cannot state that his bow passed the inspection and therefore is correct.

- b. You therefore need to be sure of your decision and ask for a 2<sup>nd</sup> opinion if you are not sure. A mistake would be embarrassing!
- c. Always ask first if you may touch the archer's equipment!
- d. Be polite and courteous to the archer and explain what you are doing.

### **What to do at the inspection:**

- a. Check that both copies of the Equipment Inspection Form are filled in correctly and have the same information.
- b. Check if the bow has passed the speed check. If not, send the archer to the speed check point before you inspect the bow. (This applies to compound bows in the only!).
- c. Check all parts of the equipment. If an archer has spare equipment which may be used after an equipment failure, the archer must also hand in that spare equipment for inspection.
- d. Check the bow and the various bow attachments, the binoculars and the arrows. The archers must show all the arrows that he intends to shoot. The inspector chooses which arrows he wishes to inspect in more detail. Normally three arrows are sufficient.
- e. If the equipment complies with the shooting style that is recorded on the inspection forms, make sure that it is the same style that is recorded on his registration form. If not, the archer must go back to the registration desk and ask them to correct the style. He then goes back to the inspection desk with the correct registration papers.
- f. If the equipment does not comply with the shooting style that is recorded on the inspection form, the archer has two choices:
  - i. He can modify the bow to comply with the style on the inspection list. Make sure it is same as on the registration papers.



- ii. He can change style (with approval of the tournament director) and goes back to the registration desk to change the style.

Do not sign the equipment inspection form until he shows proof of re-registration!

- g. Write down any concerns about the equipment on the inspection form. There is a special block allowed for that.
- h. Once the inspection is completed, again make sure that the style on the equipment inspection form and the style on the registration papers are the same! It may prevent a lot of trouble for the tournament organisers.
- i. Place an inspection sticker on the bow and sign both equipment inspection forms.
- j. Tell the archer that he must always display his registration number and have his copy of the equipment inspection form with him on the shooting range. The officers of the Technical Control may inspect his equipment at any time during the tournament.
- k. Inform him that not having this form with him may result in a penalty.
- l. The archer has now formally entered as a participant in the tournament.





# IFAA

Equipment Registration Form /  
Bogenkontrollformular / Formulario De Inspeccion De Material /  
Modulo Controllo Attrezzatura / Formulaire D'inspection Equipment

Competitor number		Bow type / Bogentyp / Tipo Arco / Tipo di arco / Arc Compound / Compuesto Recurve / Recurvo / Ricurvo / Recourber		LB	HB
Name		Style / Art / Estilo / Stile di tiro		BB	BH
Senior		Division / Altersklasse / Division / Classe di età		FS	BL
Veteran		Adult		BU	FU
Young Adult		Junior		TR	
Cub		Classification		A	B
Professional		C			
Gender	<input type="checkbox"/> F <input type="checkbox"/> M	Amateur <input type="checkbox"/> Professional <input type="checkbox"/>			
1st Bow / 1. Bogen / 1er Arco / Primo Arco / Premier Ar					
Make / Hersteller / Marca / Costruttore / Fabriquier		Model / Modell / Modelo / Modello / Modèle			
2nd Bow / 2. Bogen / 2er Arco / Segundo Arco / Seconde Arc					
Make / Hersteller / Marca / Costruttore / Fabriquier		Model / Modell / Modelo / Modello / Modèle			
Arrows (for 1st bow) / Pfeile (f. Bogen 1) / Flechas (para 1er arco) / Frece (1° arco) / Flèches (1° arc)					
Make / Hersteller / Marca / Costruttore / Fabriquier		Model / Modell / Modelo / Modello / Modèle			
Arrows (for 2nd bow) / Pfeile (f. Bogen 2) / Flechas (para 2er arco) / Frece (2° arco) / Flèches (2° arc)					
Make / Hersteller / Marca / Costruttore / Fabriquier		Model / Modell / Modelo / Modello / Modèle			
Speed Check / Geschwindigkeitsmessung / Comprobación de velocidad / Controllo velocità / Contrôle de la Vitesse					
Bow 1 / Bogen 1 / Arco 1 / Arc 1		Arrow / Pfeil / Flecha / Freccia / Flèches			
FPS.		1		FPS.	
Bow 2 / Bogen 2 / Arco 2 / Arc 2		1		FPS.	
1st bow : Speed approved / 1. Bogen Geschwindigkeit ok		2nd bow : Speed approved / 2. Bogen Geschwindigkeit ok			
1er Arco : Velocidad válida / 1° Arco : velocità regolare / 1° Arc : Vitesse approuvé		2er Arco : Velocidad válida / 2° Arco : velocità regolare / 2° Arc : Vitesse approuvé			
<input type="checkbox"/> Yes/Ja/Sì/Oui		<input type="checkbox"/> No/Nein/Non		<input type="checkbox"/> Yes/Ja/Sì/Oui	
<input type="checkbox"/> No/Nein/Non		<input type="checkbox"/> Yes/Ja/Sì/Oui		<input type="checkbox"/> No/Nein/Non	
Binoculars / Fernglas / Binoculars / Binocolo / Jumelles					
Make / Hersteller / Marca / Costruttore / Fabriquier		Model / Modell / Modelo / Modello / Modèle			
Magnification / Vergrößerung / Ampliación / Ingrandimento / Grossissement					
Binoculars are approved / Fernglas zugelassen /		Los prismáticos son aprobados / Il binocolo è regolare / Jumelles sont approuvés		<input type="checkbox"/> Yes/Ja/Sì/Oui	
				<input type="checkbox"/> No/Nein/Non	
Inspection comments / Inspektion Kommentare / Comentarios sobre la Inspección / Commenti del controllore / Commentaires d'inspection					
Notes:		Bow window requires black tape / Muss Bogenfenster abgeklebt werden / Necesita cinta negra la ventana del arco / Finestra dell'arco da nastrire / Fenetre de Arc nécessite ruban adhésif noir		Yes/Ja/Sì/Oui	
		Bow completes / Bogen stimmt / Cumple el arco / Arco in regola / Arc conformes		No/Nein/Non	
		Arrows comply / Pfeile passen / Se ajustan las flechas Frece in regola / Les flèches sont conformes		<input type="checkbox"/>	
		Equipment complies with IFAA / Ausrüstung entspricht den IFAA / El equipo cumple las normativas IFAA L'attrezzatura corrisponde IFAA / L'équipement est conforme aux IFAA		<input type="checkbox"/>	
		Signature / Unterschrift / Firma		<input type="checkbox"/>	
Equipment inspection on the range / Bogenkontrolle auf dem Feld / Inspeccion de los equipos en el rango Controllo attrezzatura sui campi di gara / L'inspection des équipements sur la gamme					
Date	OK	NOT OK	Note	Signature / Unterschrift / Firma	

A typical equipment inspection form.



## DOING THE EQUIPMENT INSPECTION

As explained previous, you as an equipment inspector provides a service to the organisers and the archers. You are not there to “catch an archer out”!

Never touch the equipment without the archer’s permission!

At the speed inspection **never** touch the bow, except to place the sticker on the limb bolt. The archer must hold the bow for you to inspect!

Always be polite and courteous.

If necessary, explain what you are doing.

## THE COMPOUND BOWS

Compound bows need additional attention as they are subjected to a speed control. No compound bow shall shoot an arrow at a speed over 300fps (91.5 m/s) and any bow that shoots faster arrows **MUST** be adjusted to reduce the speed!

When testing the speed, try and use a single chronograph. If that is not possible, please make sure that all chronographs are calibrated against each other. No two chronographs measure exactly the same. Always try and use the chronograph that records the higher speed!

It is advisable that speed checks are done with two inspectors: one to make sure that the archer draws the bow correctly, the other to make sure that the bow is aimed correctly. This inspector also records the measured arrow speed.

### How to proceed!

- a. The archer approaches the speed inspector and shows him all the bows that need to be inspected and his quiver with **all** the arrows he intends to shoot for each bow; not just a few arrows!
- b. The inspector checks the bow and the arrows against the equipment written down on the inspection sheet.
- c. The inspector (not the archer) choses three arrows from the quiver at random and hands them to the archer. These are the arrows that are used for the speed test. No other arrows shall be used. If the archer needs more arrows, he will draw the shot arrows and re-uses them!
- d. The archer places the arrow on the string and arrow rest as if the shoots a competition and draws the bow.



- e. Make sure the archer draws the bow correctly, as if he shoots in the completion. Take specific care that:
  - i. The bow is fully drawn. Check the position of the cams of the bow when it is in full draw for all the arrows. The cam should be in the same position every time he shoots an arrow.
  - ii. Make sure that the archer does not “over draw” and relaxes back to his anchor point. That will reduce the speed of the arrow. The archer must draw directly to his correct anchor point! For this test the anchor point must be the same for each arrow!
  - iii. The archer must stand in the same position and the same height for every arrow. If the chronograph is too low or too high, adjust the height of the chronograph. Do not ask the archer to “stretch up” or to bend his legs. That is a wrong procedure! Make sure that archer stands at the correct position in front of the chronograph.
  - iv. Look if the draw weight of the bow may be too high (heavy) for the archer. (He may raise the bow above his shoulder). If you believe that the archer struggles and has no proper control when drawing the bow, inform him that the way he draws is illegal and that his bow hand may not rise above the shoulder. Inform him that he may be disqualified if such draw is noticed by his fellow archers and/or Range Officer.
- f. When you are satisfied that the archer stands at the right position, the draw is correct and that the arrow is aimed correctly, the archer can release the arrow.
- g. Record the speed on the inspection form.
- h. If you are sure all is done correctly and the speed is below 280 fps you need not shoot a second arrow. It safes time!
- i. When the speed is over 280 fps the archer must shoot a second arrow. If that arrow has the same speed (you may allow a variation of 5fps), you can approve the arrow speed. If the variation is more than 5 fps, shoot the third arrow, just to make sure.
- j. When the arrow speed is 300 fps or just over or below 300 fps, all three arrows **must** be shot. The same variation of 5 fps shall be allowed. The average speed of the three arrows may not exceed 300 fps.
- k. If the arrow speed is very close to the maximum 300 fps you warn the archer that keeping the arrow speed below 300 fps is his responsibility. If during field inspections the bow is found to exceed 300 fps, even though the archer has not adjusted the



bow weight, he will be penalised and possibly disqualified. So it is advantageous to keep the arrow speed at about 295 fps to avoid the risk on an unacceptable arrow speed due to changed weather conditions or difference in altitude.

- l. If the arrow speed of two of the arrows is above 300 fps, the bow **must** be disqualified!  
Adjusting of the bow should not be done at the chronograph as it wastes time and you have many archers waiting. The archer must leave the queue to reduce the limb tension and come back for a new test.
- m. Do NOT get into an argument with the archer if he does not want to adjust his bow. That is not your function. In such a situation keep the equipment inspection form and you call the TCO, who must deal with the archer!
- n. Once the bow has been accepted, place a sticker on the limb bolt as proof that you have inspected the bow. (The sticker most likely will vibrate off during the tournament, but that is unavoidable, so do not worry about that.)
- o. Return the filled in equipment inspection forms to the archer.
- p. The speed inspection is completed and the archer can proceed to the equipment inspection tables.

## THE NEXT STEP

1. Once the compound bow archer has gone through the speed test, he can join the recurve and traditional archers in the waiting line to get his bow inspected to verify that his equipment indeed complies with the IFAA rules of the style he has registered in.
2. Keep in mind that there are several queues, each for a different style. In the example on page 6, three main queues are shown: the compound queue, the recurve queue and the longbow/historical bow queue. Make sure that an archer moves to the correct queue. You may need an assistant at that point to show the right waiting lane.
3. Once the archer reaches the inspection desk (table) he will give the inspector the inspection form that he has filled in as well as the registration paper. The inspector checks the information against each document. If there is a difference the archer must get it corrected and inform the registration desk before any further inspection can be done.
4. In the case of a compound bow, the inspector must make sure that the arrows that are presented to him are the same arrows that were used in the speed test.



## INSPECTING THE BOW

### i. THE COMPOUND BOW

There are two groups of compound bows:

#### a. The “**Freestyle bows**”.

They are grouped in Freestyle Unlimited, Freestyle Limited and Barebow.

The main characteristic of these bows is that they all have long stabilisers.

- i. The Freestyle Unlimited bow has no limitations, provided it complies with the rules as defined in Articles IV D1 and D2 of the IFAA Bylaws. The arrows may be all different.
- ii. The Freestyle Limited bow has the same rules as the Freestyle Unlimited bow, however no release aid is allowed.
- iii. The Barebow has the same rule as the Freestyle Limited bow, but no sights or potential sighting reference points are allowed. Arrows must however be all the same and vanes must be the same size even though they may differ in colour.

#### b. The “**Bowhunter bows**”.

They are grouped in Bowhunter Unlimited, Bowhunter Limited and Bowhunter.

The main characteristic of these bows is that they all have short stabilisers, limited to 12 inches (30.5 cm), and all arrows must be identical even though vanes may differ in colour.

- i. The Bowhunter Unlimited bow must also comply with the rules as defined in Articles IV D1 and D2 of the IFAA Bylaws and has a few other limitations in the type of sights.
- ii. The Bowhunter Limited bow has the same rule as the Bowhunter Unlimited bow, however no release aid is allowed.
- iii. The Bowhunter has the same rule as the Bowhunter Limited bow, but no sights or potential sighting reference points are allowed.

### ii. THE RECURVE BOW

There are three groups of recurve bows:



a. The “**Freestyle bows**”.

They are grouped in Freestyle Limited and Barebow.

The main characteristic of these bows is that they all have long stabilisers.

- i. The Freestyle Limited bow must comply with the rules as defined in Articles IV D1 and D2 of the IFAA Bylaws. Like with the compound bow, no release aid may be used.
- ii. The Barebow has the same rule as the Freestyle Limited bow, but no sights or potential sighting reference points are allowed. Arrows must however be all the same and vanes must be the same size even though they may differ in colour.

b. The “**Bowhunter bows**”.

Only one style exists in this group: the Bowhunter.

The main characteristic of this bow is that it shall have a short stabiliser, limited to 12 inches (30.5 cm)

- i. The Bowhunter bow must also comply with the rules as defined in Articles IV D1 and D2 of the IFAA Bylaws.
- ii. The Bowhunter shall have no sights or potential sighting reference points.
- iii. Arrows must be all the same and vanes must be the same size even though they may differ in colour.

iii. **THE TRADITIONAL BOW**

There are three groups of traditional bows:

a. **The Traditional Recurve bow**

This type of bow is quite similar to the Bowhunter Recurve bow, be it that it is mainly made of wood. The bow also has no arrow rest and no stabiliser. Any type of arrow may be used as long as it has natural vanes. Takedown bows are allowed.

b. **The Longbow**

This type of bow is in many ways is similar to the Traditional Recurve bow, however it may not have any recurve on the limbs and instead of a riser, has an integrated “grip” from where the limbs start. The bow must be shot with wooden arrows which must have natural vanes. Takedown longbows, splitting the bow in two parts in the grip, are permitted.





### c. **The Historical Bow**

This type of bow has one main characteristic: “The bow shall be based on the accepted design and usage during the period preceding the year 1900. The variation in bows is great and you are not expected to know all types.

It is the archer’s responsibility to show proof that the bow type did exist before 1900.

No modern materials such as poly-carbons, poly-urethane, etc. may be used in the manufacture of the bow. It is however often very difficult to establish if these materials are used or not and as Equipment Inspector you are expected to do only a visual inspection.

If you believe that the bow is not “historical” then you may ask the archer to show documented proof that the bow style is “historical”. A book or museum reference is usually sufficient.

## **WHAT TO LOOK FOR WHEN INSPECTING THE BOW**

An Equipment Inspector is not a professional who knows all the detail of each bow type.

He is normally knowledgeable about the style he shoots in competition but often does not know the details of all the other shooting styles. It is therefore strongly recommended that Equipment Inspectors inspect a limited number of shooting styles, possibly a single or two styles.

An Equipment Inspector should not be asked to inspect compound bows as well as recurve bows and/or traditional bows. The variation is too big and can become confusing. Stay within one of the three main shooting styles.

Please remember that the Equipment Inspector only inspects equipment and is not responsible to check that the archer shoots the bow in a manner that is specified in the IFAA Bylaws. For instance: an equipment inspector does not inspect the manner a longbow archer draws his bow.

### **Check the binoculars.**

When shooting a Bowhunter or 3D competition binoculars may not have incorporated range finders, marked focus dials or any other gadget that allows an archer to measure the shooting distance.



In the event of a Field competition any type of binoculars is allowed.



## THE FREESTYLE UNLIMITED BOW.

### What to look for when you inspect the bow:

#### Check the total appearance of the bow.

It must have two flexible limbs. Any type of mechanical drawing device is not allowed. Keep in mind that some bows have split limbs and some (like the “Oneida”) have composite limbs. They all qualify as “two flexible limbs”.

#### Check the bow sight.

Only sights that are accepted by the IFAA may be used. These are mainly mechanical or optical sights with or without magnification lenses.

Electronic sights and laser sights are not allowed.

#### Check the arrows.

At least three of the arrows are marked with 1, 2 and 3 rings. This is required for the Animal Round.

Any type or shape of arrow is allowed. They do not have to be similar.

### What to do if the equipment does not comply:

Call the TCO and explain the problem.

## FREESTYLE UNLIMITED (2017)

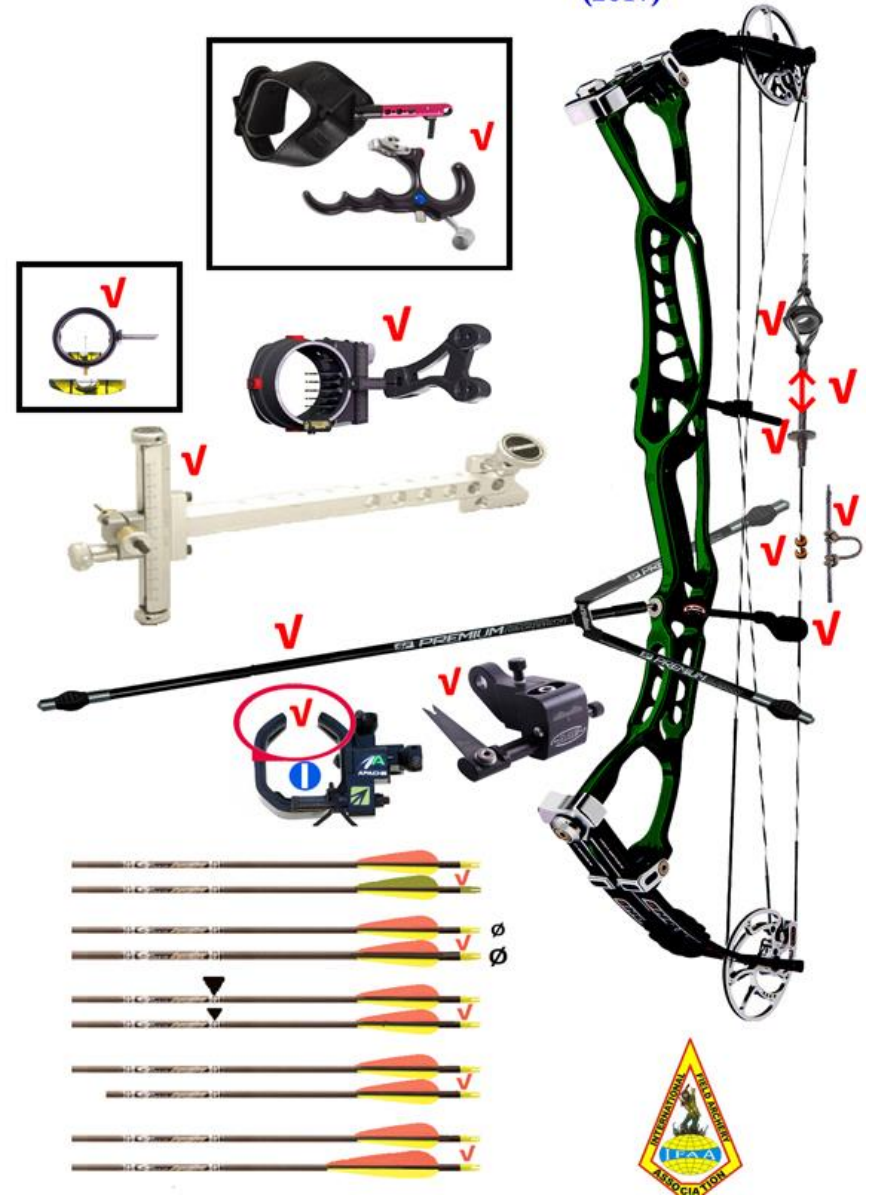

## THE FREESTYLE LIMITED COMPOUND BOW.

### What to look for when you inspect the bow:

#### Check the total appearance of the bow.

It must have two flexible limbs. Any type of mechanical drawing device is not allowed. Keep in mind that some bows have split limbs and some (like the “Oneida”) have composite limbs. They all qualify as “two flexible limbs”.

#### Check the type of release the archer will be using.

The bow is drawn with the fingers.

The archer should not have a release aid, only a tab or glove.

#### Check the arrows.

At least three of the arrows are marked with 1, 2 and 3 rings. This is required for the Animal Round.

Any type or shape of arrow is allowed. They do not have to be similar.

#### What to do if the equipment does not comply:

Call the TCO and explain the problem.

## FREESTYLE (LIMITED) COMPOUND (2017)



## THE BAREBOW COMPOUND BOW.

### What to look for when you inspect the bow:

#### Check the total appearance of the bow.

It must have two flexible limbs. Any type of mechanical drawing device is not allowed. Keep in mind that some bows have split limbs and some (like the “Oneida”) have composite limbs. They all qualify as “two flexible limbs”.

#### Check for a sight.

- There may not be any type of sight on the bow.

#### Check the bow string.

- No peep sight may be on the bow string.
- Only a single nocking point, marked by one or two locators, is allowed.
- No purpose man made markings may be on the bow string. Multi coloured twisted strings are permitted.
- A kisser button is normally not used, but it is permitted.
- String silencers outside line of vision are allowed.

#### Check the riser.

- There shall be no markings above the arrow rest. Markings on the riser must be taped for 15 cm above the arrow rest.
- String stoppers are allowed.

#### Check the draw check

- Any type of draw check is allowed but must be below the top of the arrow. (See insert 1)

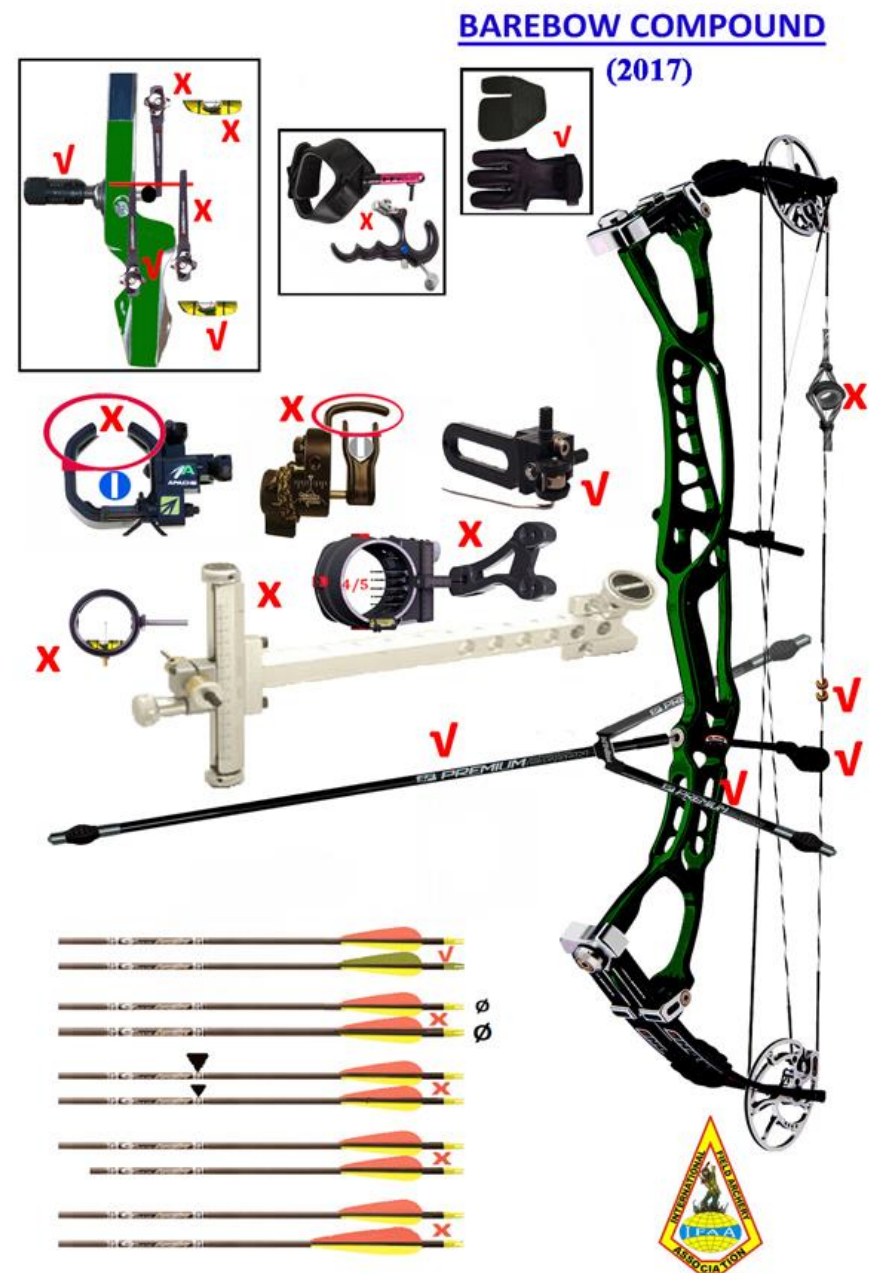

- A draw stop incorporated in the cams is allowed.

#### **Check the arrow rest.**

- No part of the arrow rest may show above the arrow.
- “Springy” type rests and plungers sometimes protrude a little above the arrow, especially when thin arrows are used. This is allowed.

#### **Check the stabiliser.**

- Any type of stabiliser is allowed. “Vee” bars are allowed.

#### **Check the arrows.**

- Any type or shape of arrow is allowed, however they must all be the same and have the same type of vanes. The colour of the vanes may differ.
- They should have no man made markings that can be used for aiming. Camo colour or similar on arrows is allowed. Cresting is also allowed.
- Check the type and code of the arrow. They should be all the same.
- Check that at least three of the arrows are marked with 1, 2 and 3 rings. This is required for the Animal Round.

#### **What to do if the equipment does not comply:**

- If the bow and/or bow attachments do not comply with the rules of the Barebow Compound style the archer must either correct the bow and/or bow attachments or he must go back to the registration desk and re-register the bow in the Freestyle Limited Compound style, if allowed by the Tournament Director.  
Make sure to follow the correct re-registration procedure.
- Arrows that do not comply must be set aside and replaced with correct ones.
- If not sure then call the TCO.



## THE BOWHUNTER UNLIMITED BOW.

### What to look for when you inspect the bow:

#### Check the total appearance of the bow.

It must have two flexible limbs. Any type of mechanical drawing device is not allowed. Keep in mind that some bows have split limbs and some (like the “Oneida”) have composite limbs. They all qualify as “two flexible limbs”.

#### Check the sight system carefully.

- It must be a pin sight with either four or five pins. A protective ring around the pins (sight guard) is allowed and the ring is allowed to have a spirit level built in. No separate spirit level is allowed!
- The distance between the inside of the guard ring and the top pin must be greater than the distance between the top pin and the one below. The same applies to the bottom. (see Figure 3 on the next page)
- No scope sight is permitted.
- The pins must be of straight stock and may not have a hood on any of them. Optical fibre is allowed as long only the end tip of the fibre is visible to the archer. “T”-shaped optical pins are not allowed.
- A light to illuminate the sight pins is allowed as long as the origin of the light cannot be used as a sighting reference point.
- The sight may not include any device that assists the archer with consistency in eye alignment, anchor point or back tension. Simply

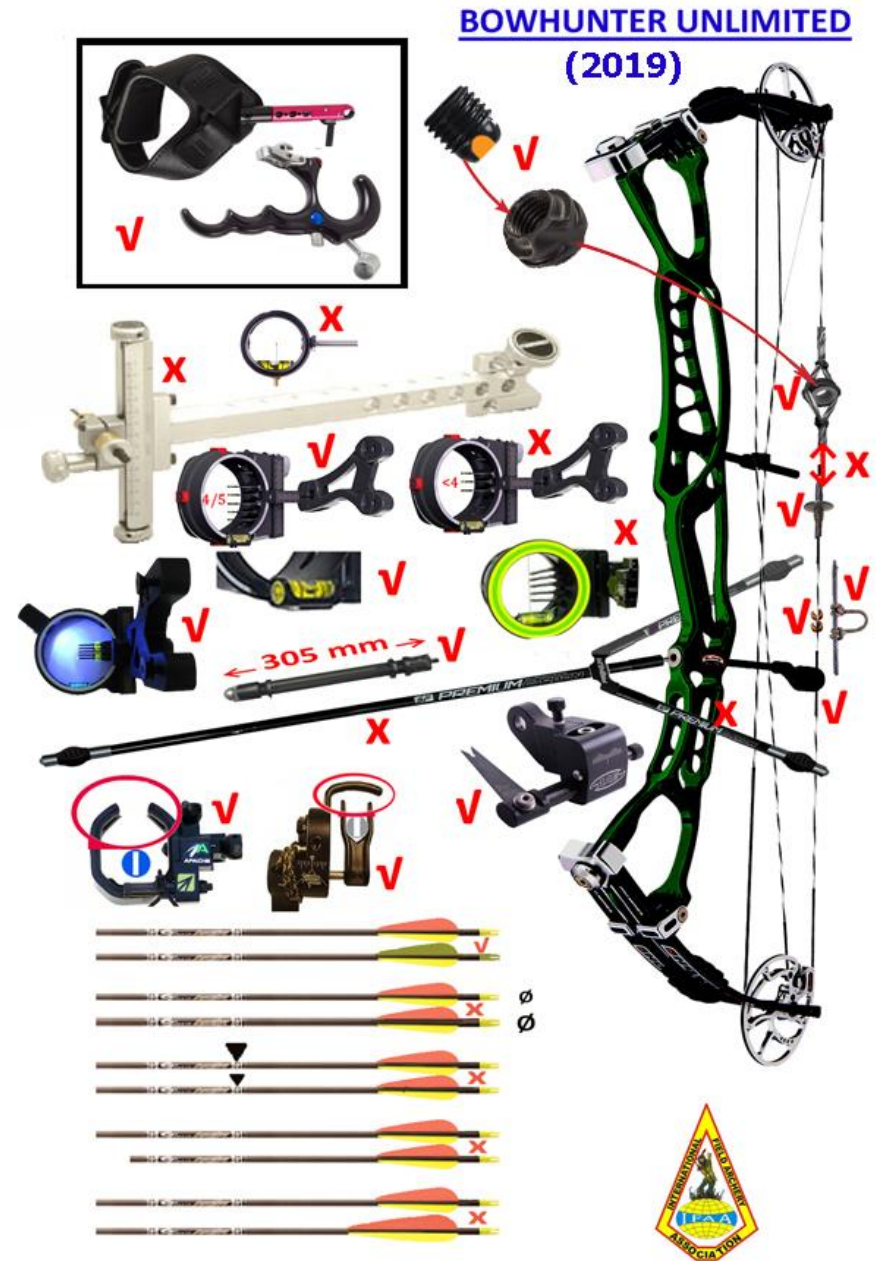

put, any “gadget” on or incorporated in the sight must be questioned.

No vertical wire is allowed in the sight.

If you are not sure, then call the TCO.

- A lens is permitted in the peep sight on the string.

### Check the riser

- String stoppers are allowed but they may not have any obvious counter weights attached. If not sure, call the TCO.

### Check the stabiliser.

- It may not extend more than 12 inches (305mm) from the front of the bow riser.
- The length of the riser is measured from the front tip of the stabiliser to the vertical on the front of the bow riser. Any extra extensions, such as the sling nut, are part of the stabiliser (see figure 1)
- The stabiliser must be straight and no side weights that move the centre of gravity to the outside of the stabiliser are allowed (Vee-bars). If not sure, call the TCO. (see also figure 2)
- The stabiliser shall be installed on the centre of the bow riser. “Off-set” stabilisers that move the centre of gravity away from the centre of the stabiliser are not allowed.(see figure 4, the stabiliser should be at the arrow position))
- No counter stabilisers or weights are allowed on the back of the bow riser. (See also “check riser”)

### Check the bow string

FIGURE 1

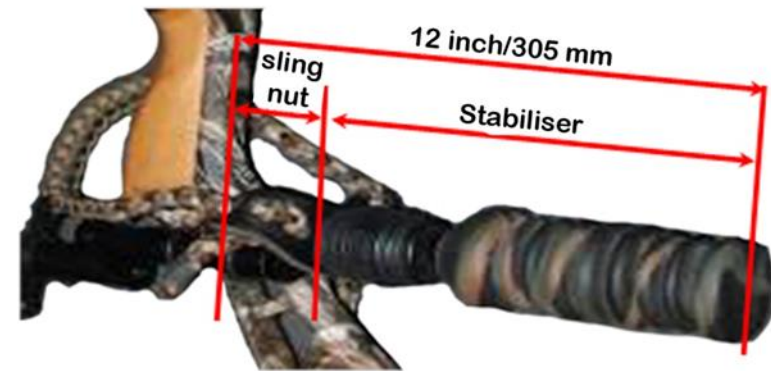

FIGURE 2



FIGURE 3

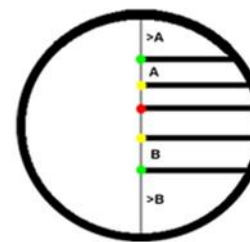

FIGURE 4





- The string may have a kisser button or a peep sight but not both!
- Only one nocking position, marked by one or two locators is allowed.

### Check the arrows.

- Any type or shape of arrow is allowed, however they must all be the same and have the same vanes. The colour of the vanes may differ. Check the type and code of the arrow. They must be all the same.
- Camo colour and crestring is allowed.
- Check that at least three of the arrows are marked with 1, 2 and 3 rings. This is required for the Animal Round.

### What to do if the equipment does not comply:

- If the bow and/or bow attachments do not comply with the rules of the Bowhunter Unlimited style the archer must either correct the bow and/or bow attachments or he must go back to the registration desk and re-register the bow in the Freestyle Unlimited style, if allowed by the Tournament Director.  
Make sure to follow the correct re-registration procedure.
- Arrows that do not comply must be set aside and replaced with correct ones.
- If not sure then call the TCO.

### THE BOWHUNTER LIMITED BOW.

Exactly the same rules for the Bowhunter Unlimited bow apply.

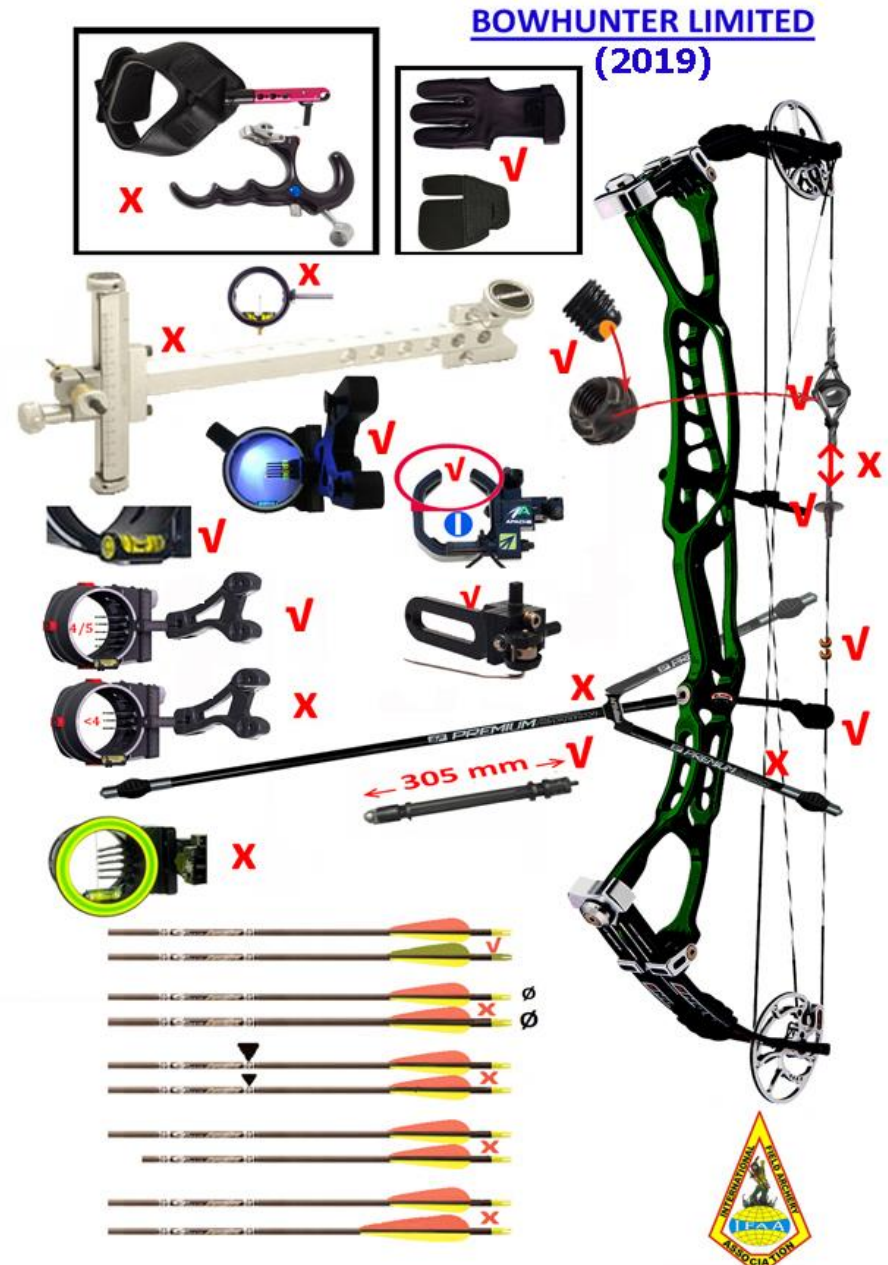



- Draw stops built in the cams are allowed.

### Check for a level.

- No level of any type is allowed.

### Check for a sight.

- No sight or sighting system of any type is allowed.

### Check the riser.

- There shall be no markings of any type on the riser above the arrow. Markings on the riser must be taped up to 15 cm above the arrow rest.
- A string stopper is allowed but it may not have any obvious counter weights attached. If not sure, call the TCO.

### Check the string.

- No marking of any type that can be used for sighting is allowed on the bow string. Multi-coloured twisted strings are allowed however.
- Only one nocking position, marked by one or two locators is allowed.

### Check the stabiliser.

- It may not extend more than 12 inches (305mm) from the front of the bow riser.
- The length of the riser is measured from the front tip of the stabiliser to the vertical on the front of the riser. Any extra extensions, such as the sling nut, are part of the stabiliser. (see figure 1)

FIGURE 1



FIGURE 2

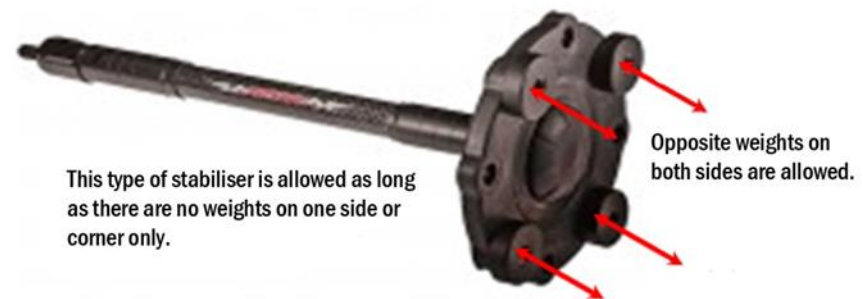

FIGURE 3

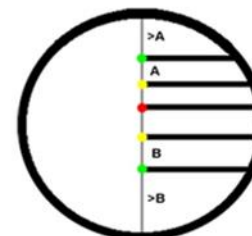

FIGURE 4



An off-set stabiliser is not allowed.

- The stabiliser must be straight and no side weights that move the centre of gravity to the outside of the stabiliser are allowed (Vee-bars). (see figure 2) If not sure, call the TCO. (see figure 2)
- The stabiliser shall be installed on the centre of the bow riser. “Off-set” stabilisers that move the centre of gravity away from the centre of the stabiliser are not allowed. (See Figure 4. The stabiliser must be where the arrow indicates.)
- No counter stabilisers or weights are allowed on the back of the bow riser.

#### **Check the arrows.**

- Any type or shape of arrows is allowed, however they must all be the same and have the same vanes. The colour of the vanes may differ. Check the type and code of the arrow. They must be all the same. Camo colour and cresting is allowed.
- Check that at least three of the arrows are marked with 1, 2 and 3 rings. This is required for the Animal Round.

#### **What to do if the equipment does not comply:**

- If the bow and/or bow attachments do not comply with the rules of the Bowhunter Compound style the archer must either correct the bow and/or bow attachments or he must go back to the registration desk and re-register the bow in the Freestyle Limited Compound style, (in the event that only the stabiliser is incorrect, Barebow Compound may also be an option), if allowed by the Tournament Director.  
Make sure to follow the correct re-registration procedure.
- Arrows that do not comply must be set aside.
- If not sure, call the TCO.



## THE FREESTYLE LIMITED RECURVE BOW.

### What to look for when you inspect the bow:

The Freestyle Limited Recurve bow is also known as the “Olympic Bow”.

The bow has little or no limitations on what is attached to the bow.

Arrows can be of any type, shape or size and they may be mixed.

Any type of suitable arrow rest is allowed and almost all types of sight are allowed.

### What is not allowed:

- The bow may only be drawn with fingers. No release aid is allowed.  
Finger protection is allowed.
- Electronic and laser sights are not allowed.

### What to do if the equipment does not comply:

Call the TCO and explain the problem.

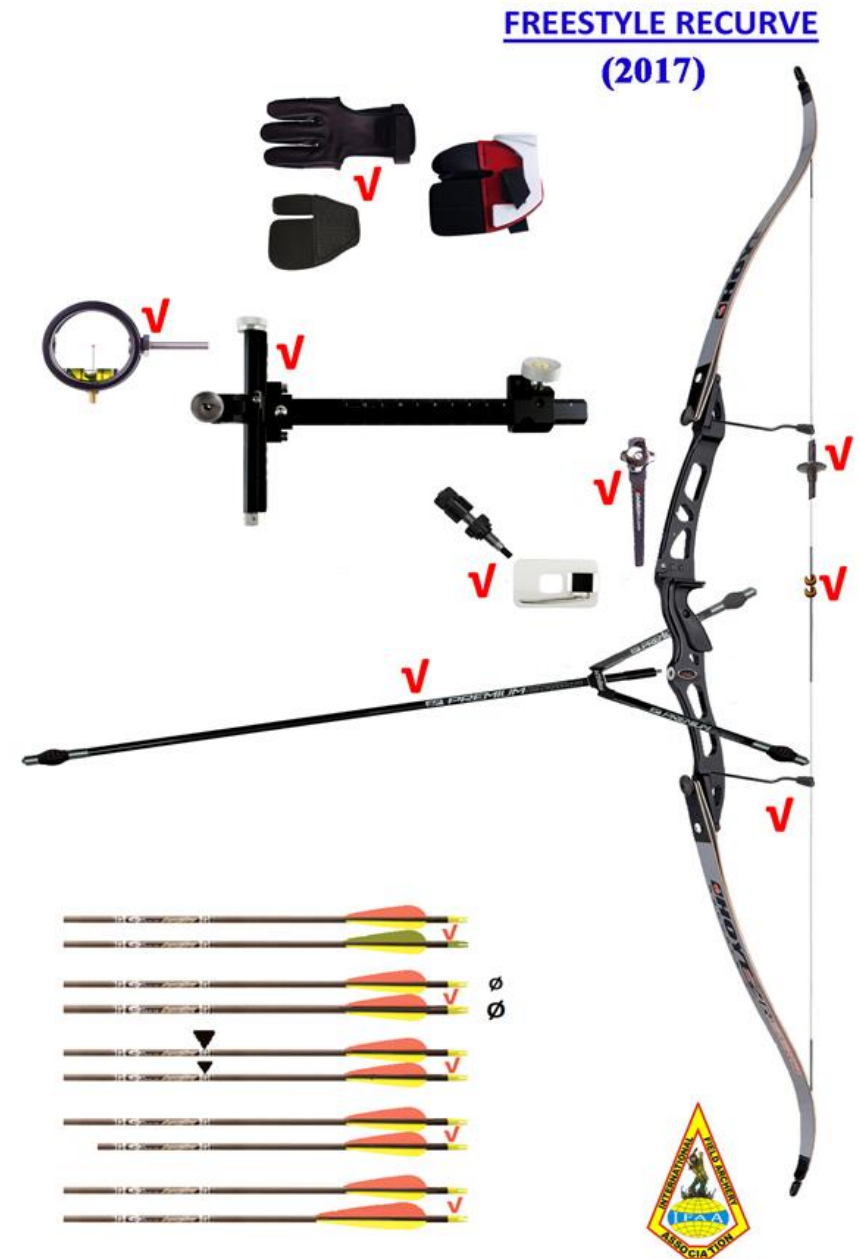

## THE BAREBOW RECURVE BOW.

### What to look for when you inspect the bow:

#### Check for a sight.

- There may not be any type of sight on the bow.

#### Check the stabiliser

- Any type of stabiliser is allowed; “Vee-bars” and counter weights are allowed.

#### Check the bow string.

- No peep sight may be on the bow string.
- Only a single nocking point, marked by one or two locators, is allowed.
- No purpose man made markings may be on the bow string. Twisted multi coloured bow strings are allowed.

#### Check the riser.

- Any type of material is allowed.
- There shall be no markings in the line of vision! (Above the arrow rest)
- If there are markings, the riser should be taped up to at least 150mm above the arrow.
- A draw check (clicker) is allowed, but it may not extend above the top of the arrow. (See insert 1)
- A spirit level is allowed, but it may not be above the top of the arrow.

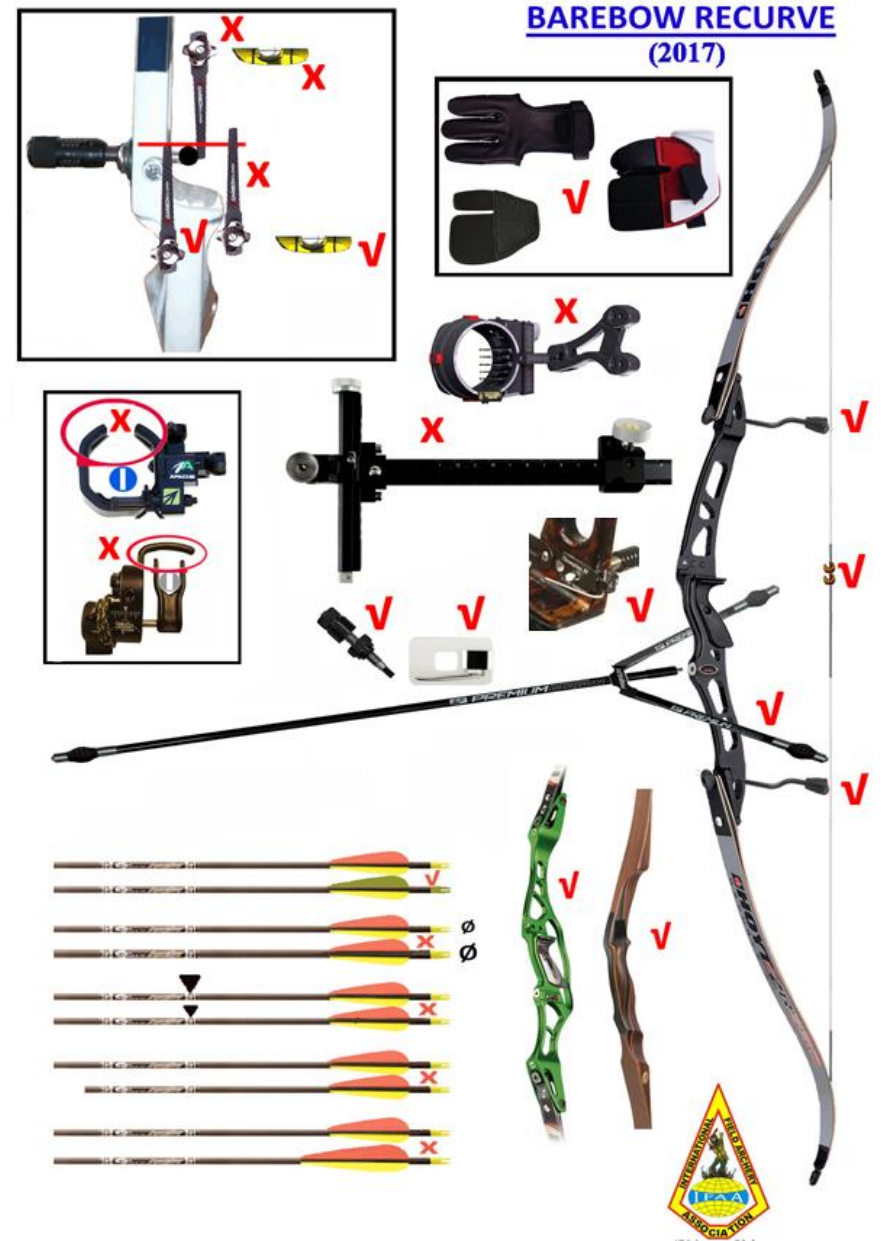

- A string stopper is allowed.

#### **Check the arrow rest.**

- No part of the arrow rest may show above the arrow.
- “Springy” type rests sometimes protrude a little above the arrow, especially when thin arrows are used. This is allowed.
- The plate of the stick-on rests and the pressure plunger often stick out above the arrow, especially when the arrow is very thin. This is allowed.

#### **Check the arrows.**

- Any type or shape of arrow can be used as long as all are the same and have the same type of vanes. The colour of the vanes may differ.
- They should have no man made markings that can be used for aiming. Camo coloured arrows and cresting are allowed however.
- Check the type and code of the arrow. They should be all the same.
- Check that at least three of the arrows are marked with 1, 2 and 3 rings. This is required for the Animal Round.

#### **What to do if the equipment does not comply:**

- Any sight must be removed.
- Markings on the riser must be taped up with black tape. The tape must be at least 150mm above the arrow rest.
- Clicker and spirit level must be adjusted to below the top of the arrow.
- Arrows that do not comply must be set aside.
- If the bow and/or bow attachments do not comply with the rules of the Barebow Recurve style the archer must either correct the bow and/or bow attachments or he must go back to the registration desk and re-register the bow in the Freestyle Limited Recurve style, if allowed by the Tournament Director.
- Make sure to follow the correct re-registration procedure.
- Follow the correct re-registration procedure



## THE BOWHUNTER RECURVE BOW

### What to look for when you inspect the bow:

#### Check for draw length control.

- No kisser button on the string is allowed.
- No draw check (clicker) is allowed.

#### Check the arrow rest.

- Any type of arrow rest may be used as long as no part of the rest sticks above the arrow. Some stick-on arrow rests are higher than the top of the arrow. That is allowed. Sometimes a “springy” type arrow rest and the pressure button may extend above very thin arrows. That is allowed.

#### Check for a level.

- No level of any type is allowed.

#### Check for a sight.

- No sight or sighting system of any type is allowed.

#### Check the riser.

- Any type of material can be used for the riser.
- If there are markings in the window, the riser should be taped up to at least 150mm above the arrow.

#### Check the string.

- No marking of any type that can be used for sighting is allowed on the bow string. Multi-coloured twisted strings are allowed however.





- Only one nocking position, marked by one or two locators is allowed.

### Check the arrows.

- Any type or shape of arrow can be used; however they must be the same. The colours of the vanes may be different. Check the type and brand of arrows.
- Check that at least three of the arrows are marked with 1, 2 and 3 rings. This is required for the Animal Round.

### Check the stabiliser.

- It may not extend more than 12 inches (305mm) from the front of the bow riser.
- The length of the riser is measured from the front tip of the stabiliser to the vertical on the front of the riser. Any extra extensions, such as the sling nut, are part of the stabiliser (see figure 1)
- The stabiliser must be straight and side weights that move the centre of gravity to the outside of the stabiliser (Vee bars) are not allowed. (See also figure 2). If not sure, call the TCO.
- The stabiliser shall be installed on the centre of the bow riser. “Off-set” stabilisers that move the centre of gravity away from the centre of the stabiliser are not allowed. (See figure 4: The arrow must be in the position of the arrow.)

FIGURE 1

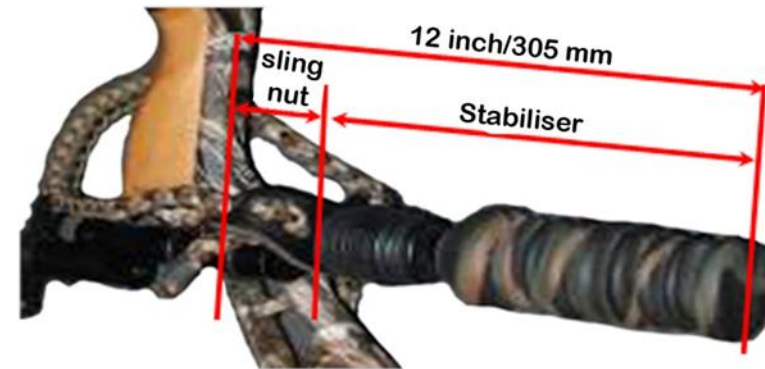

FIGURE 2



FIGURE 3

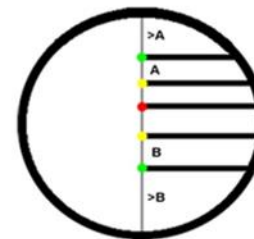

FIGURE 4



An off-set stabiliser is not allowed.

- No counter stabilisers or weights are allowed on the back of the bow riser. A string stopper is allowed but it may not have any obvious counter weights attached. If not sure, call the TCO.

**What to do if the equipment does not comply:**

- Any sight or kisser button must be removed.
- Any type of draw check must be removed.
- Markings on the riser must be taped up with black tape. The tape must be at least 100mm above the arrow rest.
- A bow string with sight markings must be replaced.
- Arrows that do not comply must be set aside.
- If the bow and/or bow attachments do not comply with the rules of the Bowhunter Recurve style the archer must either correct the bow and/or bow attachments or he must go back to the registration desk and re-register the bow in the Freestyle Limited Recurve style, (in the event that only the stabiliser is incorrect the Barebow Recurve is also an option), if allowed by the Tournament Director. Follow the correct re-registration procedure! If not sure then call the TCO.



## THE TRADITIONAL RECURVE BOW.

### What to look for when you inspect the bow:

#### Check for draw length control.

- No kisser button is allowed on the bow string.
- No draw check (clicker) of any type is allowed.

#### Check the arrow rest.

- No arrow rest of any type may be used. The arrow must be shot from the hand or from the bow shelf.
- The bow shelf may contain a thin piece of leather or similar, glued to the riser and a leather piece or “carpet” on the shelf to protect the bow riser.

#### Check for a level.

- No level of any type is allowed.

#### Check for a sight.

- No sight or sighting system of any type is allowed.

#### Check the riser.

- The riser shall be made mainly from wood. Lamination, made with fibres and polymers or similar, to reinforce the riser, is allowed. There is no specification on the thickness
- There shall be no markings of any type on the riser above the arrow.

#### Check the limbs

- The limbs shall have a wood core which may be laminated on the outside with glass or carbon fibre, or similar.

## TRADITIONAL RECURVE (2017)



### **Check the string.**

- No marking of any type that can be used for sighting is allowed on the bow string. Multi-coloured twisted strings are allowed however.
- Only one nocking position, marked by one or two locators is allowed.
- No string stopper is allowed.

### **Check the arrows.**

- Any type or shape of arrow may be used as long as they are all the same.
- Vanes must be made from natural material (feathers). Colours of these vanes may be different.
- Check the type and brand of arrows. They should all be the same.
- Make sure that three arrows are marked with 1, 2 or 3 rings. That is required for the animal round.

### **Check for a stabiliser.**

- No form of stabiliser is allowed.

### **What to do if the equipment does not comply:**

- Any sight or kisser button must be removed.
- Any type of draw check must be removed.
- Stabilisers of any type or size must be removed.
- Markings on the riser must be taped up with black tape. The tape must be at least 100mm above the arrow rest.
- A bow string with sight markings must be replaced.
- Arrows that do not comply must be set aside and new arrows presented.
- If the bow and/or bow attachments do not comply with the rules of the Traditional Recurve style the archer must either correct the bow and/or bow attachments or he must go back to the registration desk and re-register the bow in the Bowhunter Recurve style, if allowed by the Tournament Director.
- Follow the correct re-registration procedure!





alignment gauges and the bow string.

- 11. The side of the window shall be slanted over the full length and rounded off. (No sudden directional changes are allowed.)

**Check the limbs**

- 12. The limbs may not show any type of recurve, even very small.  
To check that, place a string from the base of the tip reinforcing to the top/bottom of the riser and make sure that the string stays in contact over the full length the bow limb.  
Check the brace height (BH) if you believe that the string is twisted shorter to take out the recurve in the bow limbs. Brace height should be around 15-17 cm. Record the BH on the inspection sheet if you believe that the bowstring has been shortened.
- 13. The limb tip reinforcement may not be longer than 50mm (measured from the string groove) and not be thicker than 20mm.

**Check the string.**

- 14. No marking of any type that can be used for sighting is allowed on the bow string. Multi-coloured twisted strings are allowed however.
- 15. Only one nocking position, marked by one or two locators is allowed. Ball nocks are allowed.
- 16. String silencers no closer than 30 cm above or below the nocking point are allowed

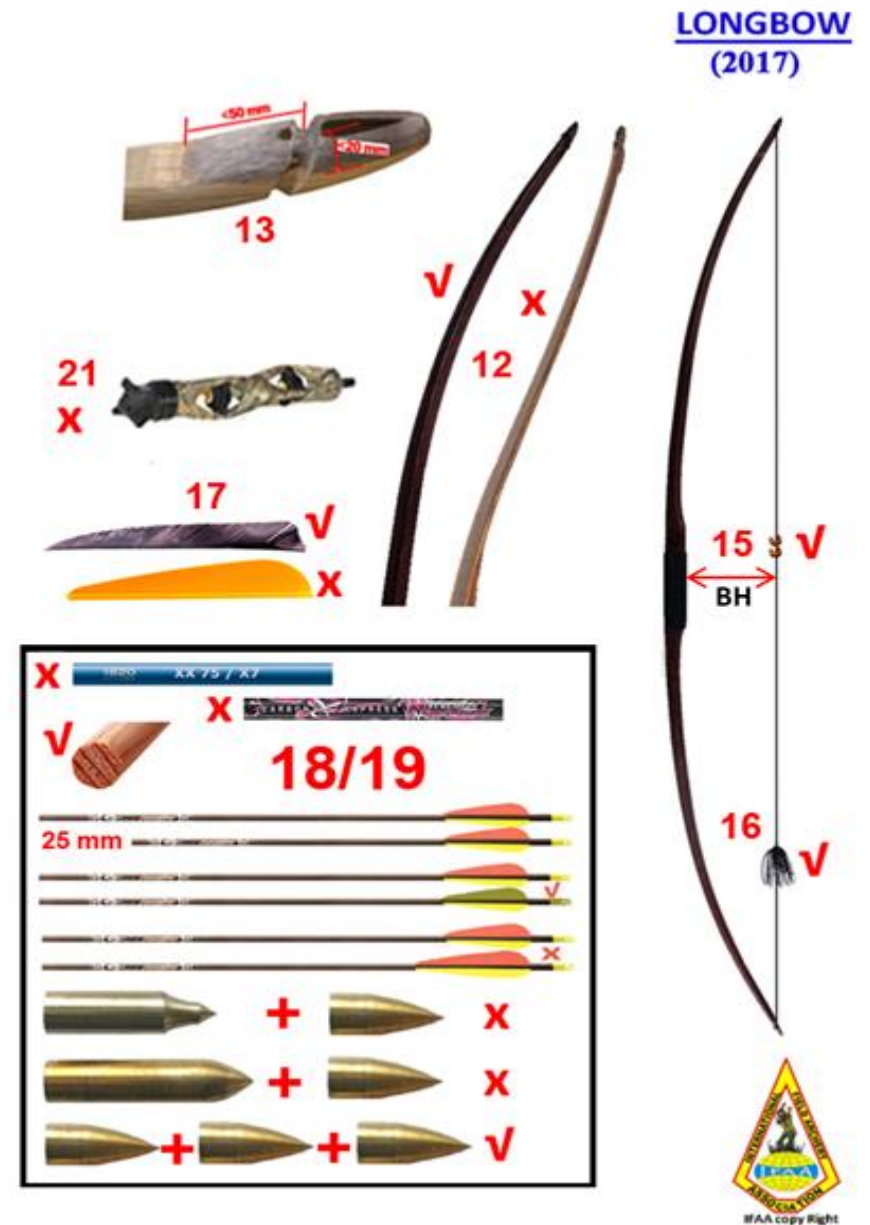

### **Check the arrows.**

17. Any type or shape of wooden, bamboo or cane arrows may be used as long as they are all the same. They may vary in length by 25mm.  
Make sure that the arrow is not a wood “look alike”. Some carbon arrows have wood laminated on the outside. They are not allowed.
18. Vanes must be made from natural material (feathers) and must be the same length. Colours of these vanes may be different.
19. Check the piles (arrow points). All must be the same.
20. Make sure that three arrows are marked with 1, 2 or 3 rings. That is required for the animal round.

### **Check for a stabiliser.**

21. No form of stabiliser is allowed.

### **General.**

In general the bow should have no attachment, other than silencers and nock locators on the string.

### **What to do if the equipment does not comply:**

- All illegal accessories must be removed.
- Markings on the riser must be taped up with black tape. The tape must be at least 150mm above the arrow rest.
- A bow string with sight markings must be replaced.
- Arrows that do not comply must be set aside and replaced with accepted ones.
- If the bow does not comply with the rules of the Longbow style the archer must either correct the bow or he must go back to the registration desk and re-register the bow in the Traditional Recurve or the Bowhunter Recurve style, if allowed by the Tournament Director. Follow the correct re-registration procedure!



## THE HISTORICAL BOW.

### What to look for when you inspect the bow:

Although you may be the Equipment Inspector to check the Historical bows, you are not expected to know the many various historical bows.

The suggested way to attend to these bows is as follows:

- All these bows must be based on the accepted design and usage during the period before the year 1900.  
If you are not certain, ask the archer for proof that the design of this bow existed before the year 1900.
- The arrows for this type of bow are normally shot from the bow hand, but there are several types that have a cut in window and/or shelf.  
If you are not certain, ask the archer for proof that the design of this bow existed before the year 1900.

### Check the materials of the bow.

- The bow shall be constructed of wood or materials that were used during the period of the bow's historical usage (bone, horn, etc.). Modern materials such as carbon, glass, epoxy and nylon may not be used. The standard bowstring material shall be polyester. You only do a visual inspection and sometimes the use of these modern materials is difficult to see.

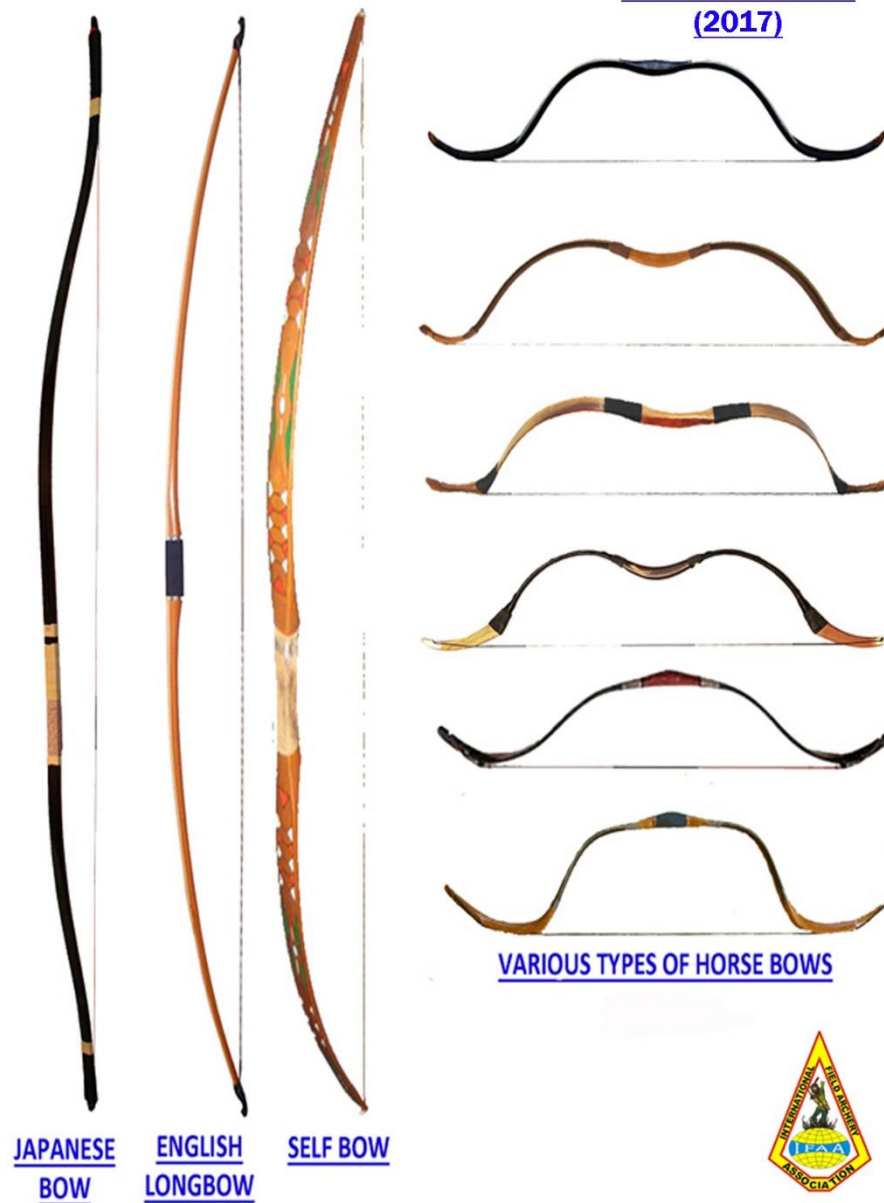



If you are not certain, ask the archer for proof by the manufacturer that only historically correct materials are used.

If you suspect the use of illegal material, make a note on the inspection form.

### **Check the arrows.**

- The arrows shall be made of wood (bamboo or cane): they shall have natural vanes (feather) that are all the same. Their colour may be different.
- The arrows must all have the same arrow points.
- The arrows must be free of any marks or blemishes that can be used as sighting aids and shall not vary in length by more than 25mm at the start of the competition.
- Modern arrow points or piles as well as modern nocks are allowed. Nocks that are cut into the shaft are only permitted when these are strengthened with appropriate materials.

### **Accessories**

- Accessories such as woven nocking point indicators, thumb rings, arrow rest and hand held overdraws are allowed, provided that such accessory was used during the historic use of the bow.

If you are not certain, ask the archer for proof that the accessory to this bow was used and when it was used originally.

### **What to do if the equipment does not comply:**

Normally a “Historical bow” cannot be corrected by the archer to fit that style and thus should be rejected for that style.

Archers will have to re-register in another style.

Normally these bows can be re-registered as a Longbow or a Traditional Recurve Bow; however bows with recurved limbs that are made mainly of synthetic material (glass fibre, carbon fibre) may have to be re-registered in the Bowhunter Recurve style.

Follow the correct re-registration procedure.



